

Install Manual

(QPI-AUDI-A4L-V2.1)

Release Date	2014.09.22
Model	QPI-AUDI-A4L-V2.1
Firmware Date	

Warning / Caution



Warning

- When installing the main unit, do not remove or alter existing vehicle fasteners, including nuts, bolts, screw, clips, and fittings. Never detach, move or alter existing vehicle wiring, including electrical grounds and straps. Alteration of existing vehicle components may make vehicle unsafe to operate. Should be no any electronic devices or magnetic pole around installation place.
- Air bags are vital part of a safety system. Never install main unit in a way which will alter air bag wiring or interfere with air bag deployment. Air bags must function properly in the event of an accident.
- Before installing, check the location of pipe, tank, electrical cables and others.
- Read and follow the instruction manual.
- Wiring location must not interfere driving, get in or out from car.
- Use electrical tape to insulate the ends of all wires, even if they are not used. Proper insulation prevents arcs, shocks and fires.
- When installation is complete, test all vehicle electrical systems to ensure they operate correctly, including lights, horn, brake lights, and emergency flashers.
- According to our sales policy, any problems caused by user's mistake, careless can not be guaranteed.



Caution

- All steps of installation should be done by well-trained specialist.
- During installation ignition key should be taken off and after all installation finish connect power cable with interface for the last step.
- Do not install the main unit in places where it ma be exposed to dew condensation (around the air conditioning hose, etc), or in locations where it may come in contact with water, high levels of moisture, dust or oily smoke
- Install wiring in a manner in which cables will not come in contact with metal parts. The wiring may be damaged by contact with metal parts, resulting in fire and shocks. Avoid all contact with hot surfaces when wiring the main unit. High temperatures may damage wiring, causing shorts, arcing and fires.
- Kindly check all parts are in the box, when receiving the product, if anything missing, inform to the supplier or manufacturer.

Table of Contents

1. Specifications	
1.1 Main Specifications	1
1.2 Features	2
1.3 System Diagram	3
1.4 Components	4
1.5 Exterior	5
2. Installation	
2.1 Installation Diagram	6
2.2 Installation	7
3. Settings	
3.1 DIP Switch	8
3.2 Remote Control	9
3.3 Factory Menu	
3.3.1 Image, Park	10
3.3.2 UTIL1	12
3.3.3 UTIL2	14
3.4 Original Button Usage	18
3.5 OSD	19
4. Trouble Shooting	21

1. Specifications

1.1 Main Specifications

1. Car Compatibility
NEW A4 without MMI 2008~
2. Components
Interface* 1EA
3. MULTIMEDIA INTERFACE input specification
 - 3 * A/V input (video external input)
 - 1 * CVBS(Rear Camera) input
 - 1 * Analog RGB input (Navigation system output)
 - 1 * LCD input (Car system input)
4. MULTIMEDIA INTERFACE output specification
 - 1 * LCD output
5. Power specification
 - Input power : 8VDC ~ 18VDC
 - Consumed power : 5WATT
6. Switch input mode
 - External display skip function : through DIP switch, can control each video input
 - Through remote control, can change input mode
 - Through CAN or rear lamp cable, rear camera can be detected

1. Specifications

1.2 Features

- Easy installation through connection with command
- Able to control NAVI, DVD, DTV function by using I-Drive Controller
- Able to adjust DVD, NAVI display on screen
- Improved Screen Display (user-oriented interface)
- Mode change through original button
- Provide power cable to connect with rear camera
- Dynamic PAS(Parking assistance system)+PDC, moving parking line according movement of steering wheel

1. Specification

1.3 System Diagram

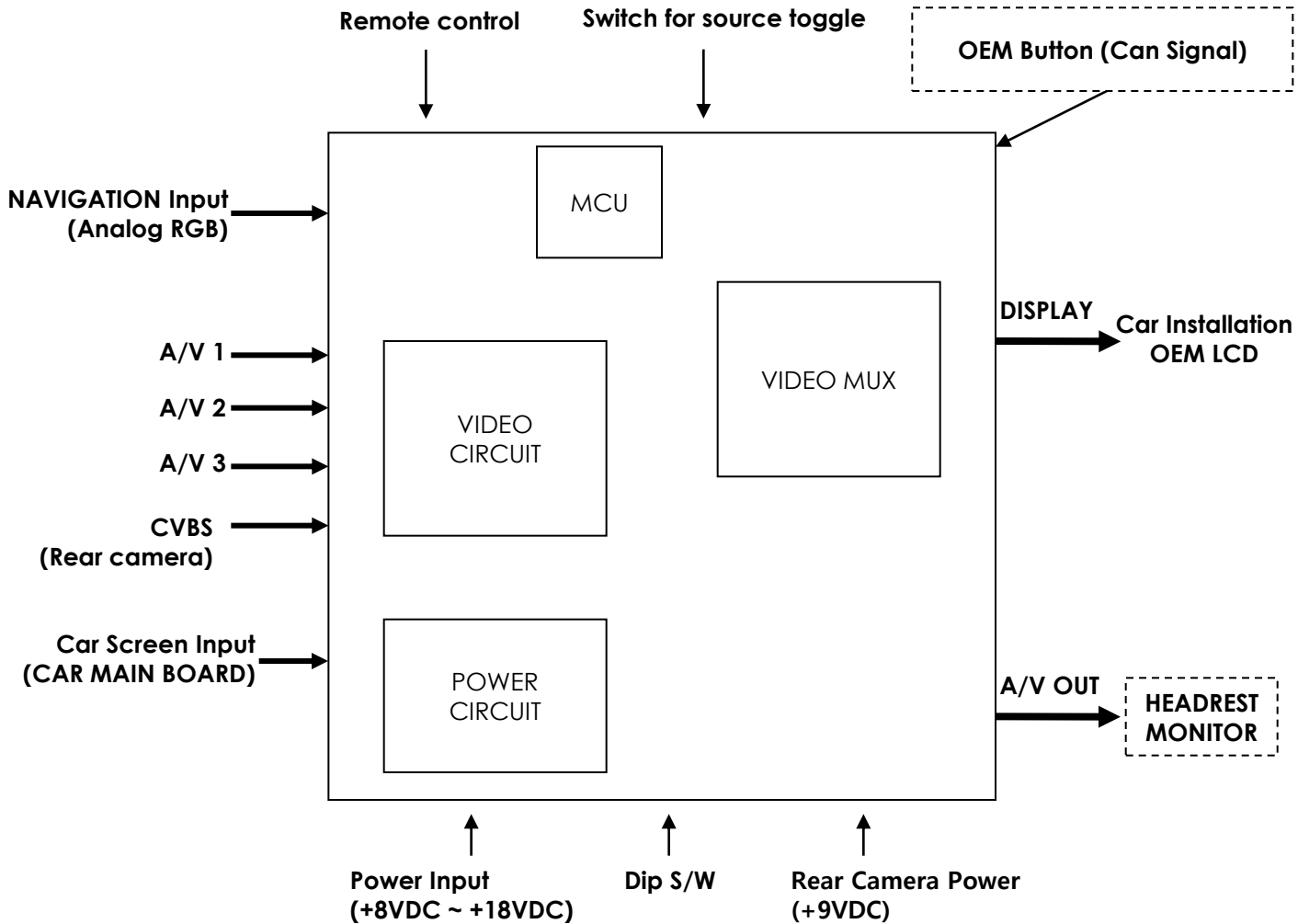

1. Specification

1.4 Components

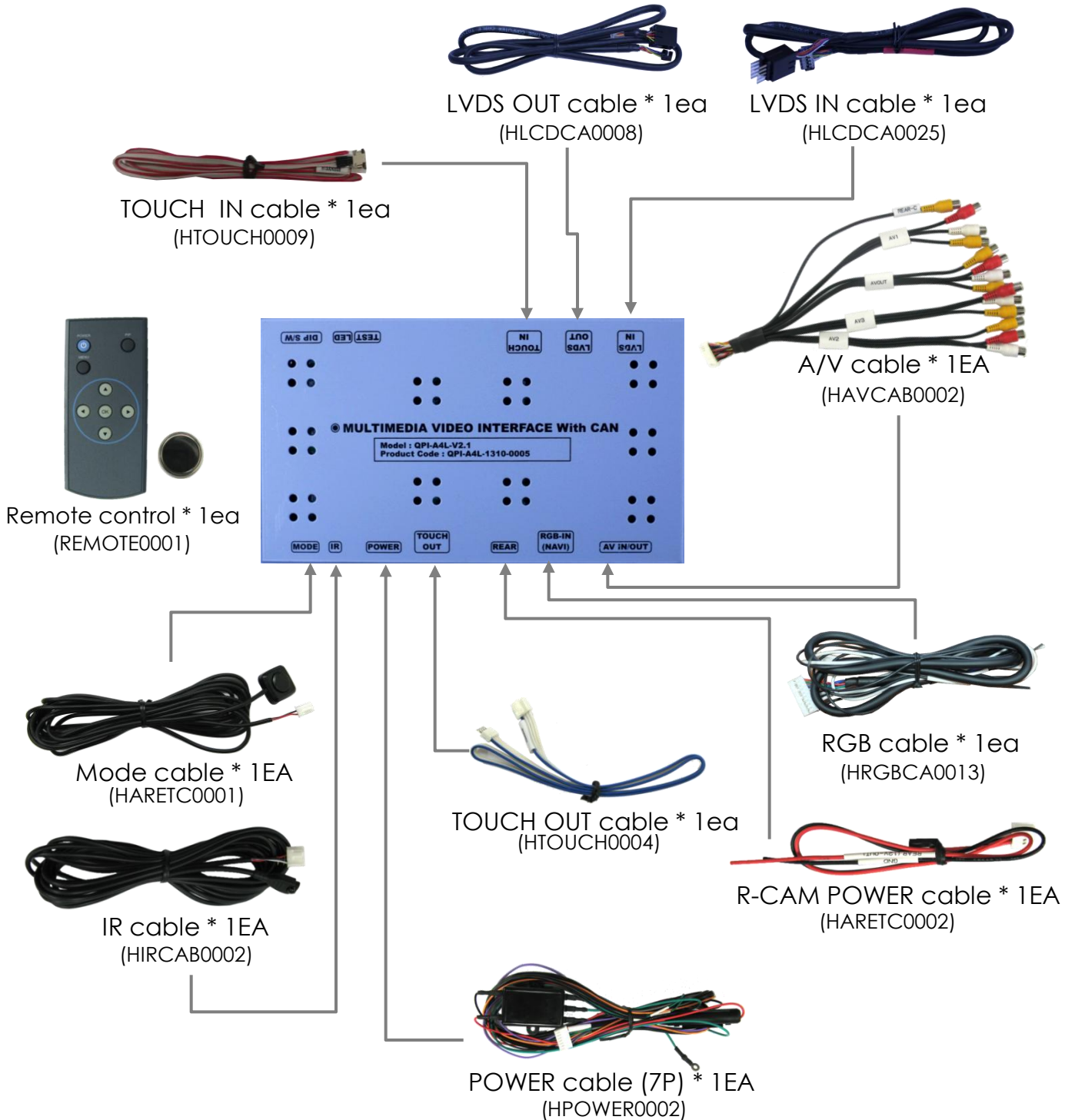

1. Specifications

1.5 Exterior

Dimension

Width 160mm
Length 97.5mm
Height 21.1mm

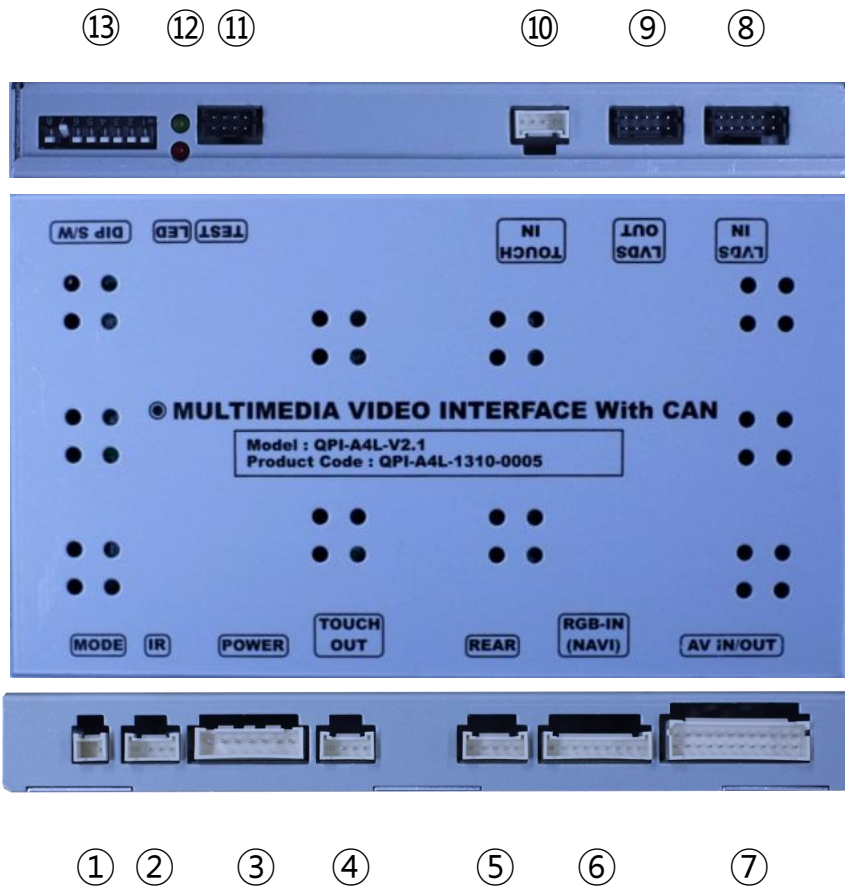

- ① MODE
- ② IR
- ③ POWER
- ④ TOUCH OUT
- ⑤ REAR
- ⑥ RGB-IN(NAVI)
- ⑦ AV IN/OUT
- ⑧ LVDS IN
- ⑨ LVDS OUT
- ⑩ TOUCH IN
- ⑪ TEST
- ⑫ LED
- ⑬ DIP S/W

2. Installation

2.1 Installation Diagram

Connecting CAN wire

Connect CAN-H-HS(Brown+Green-3Pin) of the interface to CAN High(Orange+Brown) of the car
 Connect CAN-L-HS(Green-4pin)of the interface to CAN Low(Orange+Green)of the car

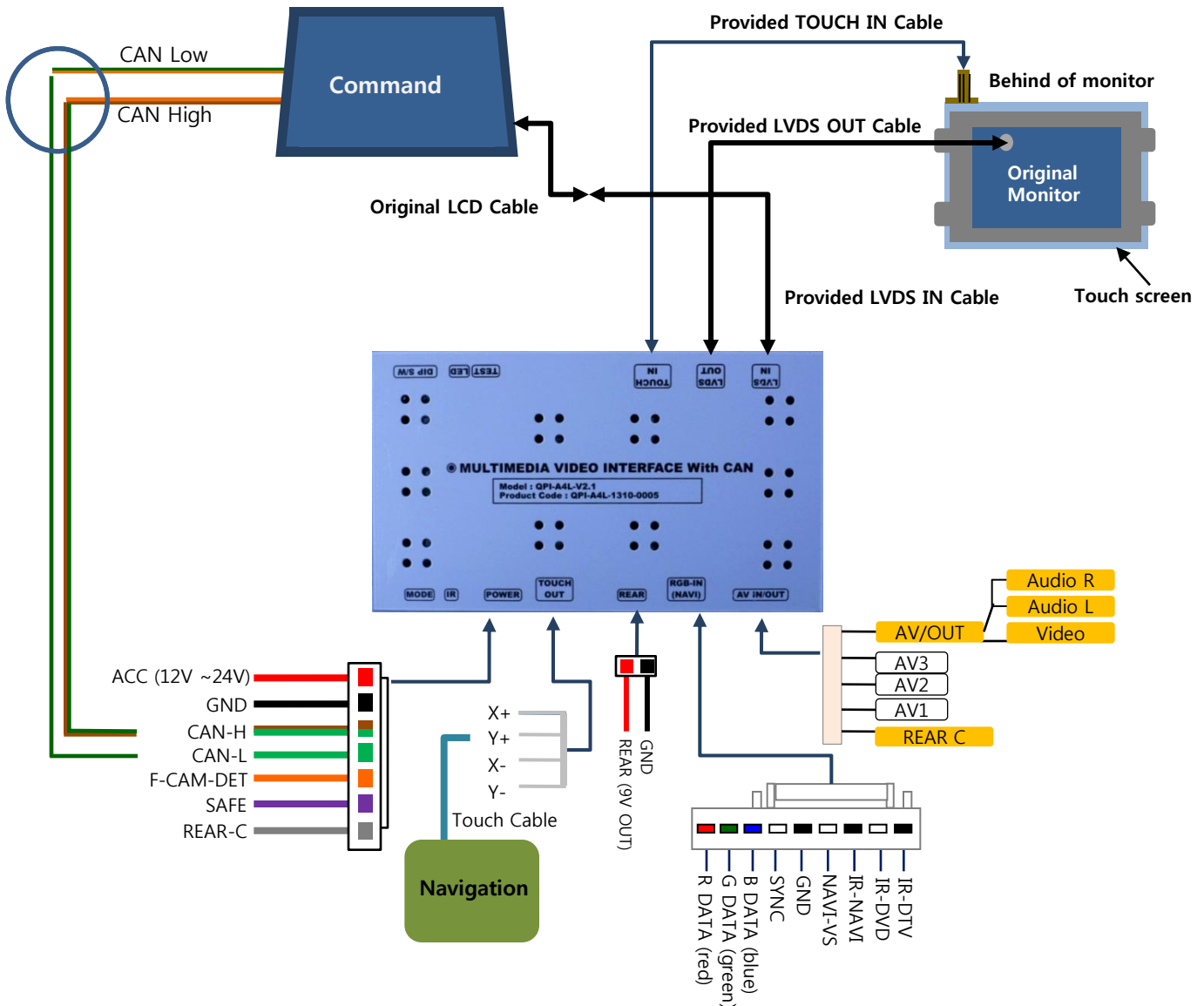

2. Installation

2.2 Installation

1. Connection of LCD wires

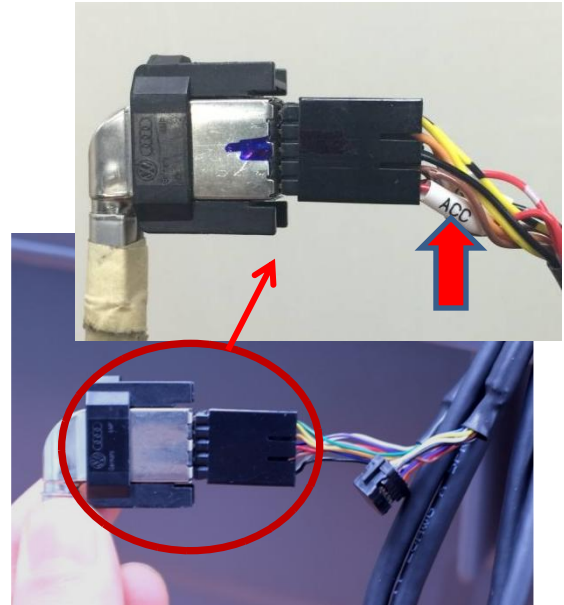

-Please pull away an original LCD cable from a monitor and connect the original LCD cable to a supplied LVDS-IN cable.

※ Please refer to the above photo. ACC wire should be placed down. The monitor would not be turned on if you connect in reverse.

-Connect the opposite side of original LVDS IN cable to LVDS-IN port in the interface.



Connect a supplied LVDS-OUT cable to OEM Monitor and Connect the opposite side of the supplied LVDS-OUT to a LVDS-OUT port in the interface.

2. Installation

2.2 Installation

2. Connecting CAN Wires

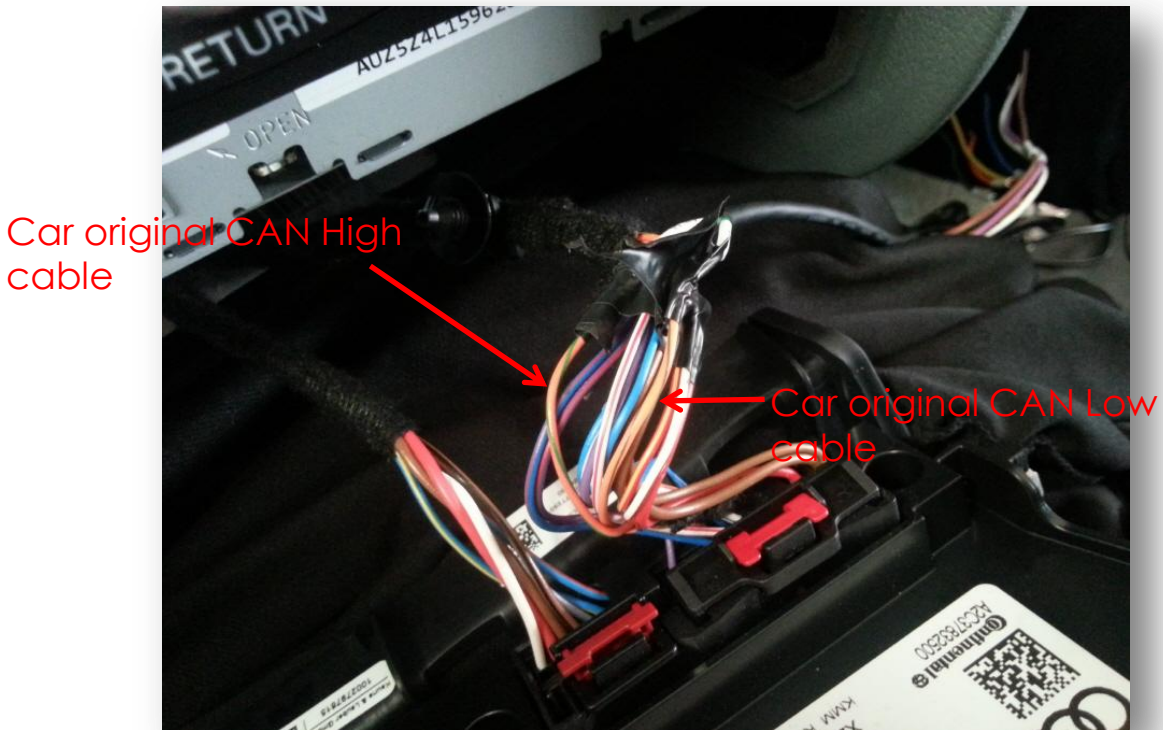

Connect car original CAN high cable (orange + green) with interface's CAN high cable (green +brown).
Connect car original CAN low cable (orange + brown) with our interface's CAN low cable (green).

3. Settings

3.1 DIP Switch

- ※ Example DIP S/W usage
 - Use input mode : A/V2, A/V3
 - Use original navigation
 - External rear camera



※ ON : DOWN / OFF : UP
 Default : #8 OFF

- ▷ DIP S/W : 1,2 → ON (hide INPUT MODE)
- ▷ DIP S/W : 3 → OFF (A/V2 display)
- ▷ DIP S/W : 4 → OFF (A/V3 display)
- ▷ DIP S/W : 5 → OFF
- ▷ DIP S/W : 6 → OFF
- ▷ DIP S/W : 7 → ON (display external rear cam)
- ▷ DIP S/W : 8 → OFF

<i>PIN</i>	<i>Function</i>	<i>Dip S/W Selection</i>
1	Displaying RGB input	ON : RGB mode skip OFF : RGB mode display
2	Displaying A/V 1	ON : A/V 1 mode skip OFF : A/V1 mode display
3	Displaying A/V 2	ON : A/V 2 mode skip OFF : A/V2 mode display
4	Displaying A/V 3	ON : A/V 3 mode skip OFF : A/V3 mode display
5		N.C
6		N.C
7	Setup of rear camera use	ON : CVBS4 OFF : MAIN
8	Reset factory settings (not use for user)	ON : Product factory reset OFF : DEFAULT

※ Please make sure to disconnect the power cable of the interface and reconnect the power cable again to apply the dip switch setting whenever changing DIP switch. Otherwise, DIP switch setting will not be applied.

3. Settings

3.2 Remote Control



<i>Key</i>	<i>Function</i>
POWER & PIP	Unavailable
MENU	Activating OSD menu
OK	Making a selection, changing image display
▲	Moving upward
▼	Moving downward
◀	Moving leftward (If you press this button 2 seconds long, you can access the factory mode.)
▶	Moving rightward (If you press this button 2 seconds long, you can reset all the data about user environment.)

3. Settings

3.3.1 FACTORY MODE-IMAGE, PARK

FACTORY mode – Press ◀ button 2 seconds long on the remote control.



□ IMAGE

Adjust navigation position and size

H-POSITION : Move display horizontally

V-POSITION : Move display vertically



□ PARK

PAS TYPE : Selecting Type of parking guide line

- NOT USED : Not use Parking guide line
- PAS ON : Selecting Dynamic Parking guide line
- PAS OFF : Selecting fixed Parking guide line

PAS SETUP : Adjusting the position and Selecting type of the parking guide line

REAR TYPE : Choose rear camera recognition

* LAMP - Detecting the rear view camera via rear lamp (Installer must connect "Rear-C" cable of the power cable to the rear lamp of the car.)

*CAN - Detecting the rear view camera by CAN signal (Installer must connect "CAN" cable of the power cable to the "CAN" cable of the car.)

SAFE ENABLE : If your car is connected with CAN cable and it is in "ON" state, you can NOT watch DVD or A/V except original image or navigation while driving. At that time the screen get back to the main (default : OFF)

RADAR ENABLE : When set the gear to "R", Display PDC

3. Settings

3.3.1 FACTORY MODE-IMAGE, PARK

PAS SETUP

Go to Factory Menu, choose PAS SETUP, by using OK button change
H-POS → V-POS → TYPE

H-POS

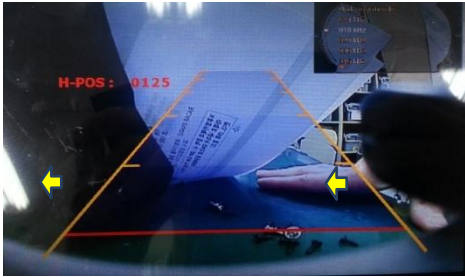

In H-POSITION, use ◀, ▶ on remote control, to adjust parking guideline left and right.

V-POS

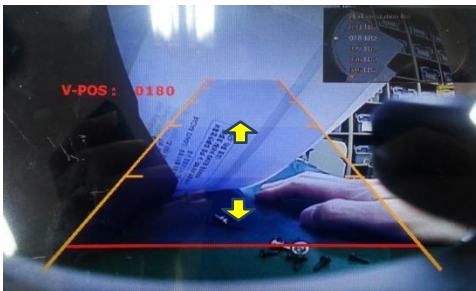

In V-POSITION, use ▲, ▼ on remote control, to adjust parking guideline up and down.

TYPE



In TYPE, use ▲, ▼ on remote control, to select parking guide line Type for rear camera.

(0001 : wide parking guide line

0000 : narrow parking guide line

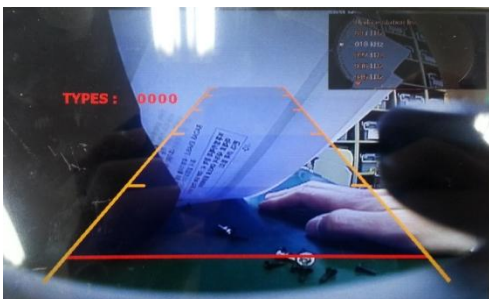

3. Settings

3.3.2 FACTORY MODE-UTIL1

FACTORY mode – Press ◀ button 2 seconds long on the remote control.

▪ Setup for navigation



UTIL1 – NAVI MODEL

Definition of the navigation resolution

DEFAULT : default, 400X234, in low resolution

LS-901(WQVGA) : 800x480 in high resolution, for Chinese, Taiwan

PAPAGO(WQVGA) : 480x234 in low resolution, for Taiwan

*** Go into FACTORY/ IMAGE (as shown right) and adjust the position and the size of the navigation after setting the definition of the navigation**

▪ Setup for car model



UTIL1 - CAR MODEL

Selecting model of the car

A4L-NEW

A4L-OLD

3. Settings

3.3.2 FACTORY MODE-UTIL1

FACTORY mode – Press ◀ button 2 seconds long on the remote control.



UTIL1 – AVOUT SELECT

Selecting background sound
After
returning navigation or original
mode

DEFAULT : Selecting AV sound
just before changing
navigation or original mode
from the AV mode

AV 1~3 : Sound of the selected
AV source 1~3



UTIL1 - FACTORY RESET

FACTORY MODE RESET

3. Settings

3.3.3 FACTORY MODE-UTIL2

FACTORY mode – Press ◀ button 2 seconds long on the remote control.



UTIL2 - I_DRV REMOTE

Choose DTV and DVD model to be control I_DRV function

LI-1DISC
NEC-6DISC
USER(when using IR MEMORY)

•Select DVD model: Setting on AV1 Mode

•Select DTV model : Setting on A/V2 mode

UTIL2 - I_DRV CONTROL

Selecting whether to use I_DRV function or not

ON / OFF

A/V1 : Control DVD Remote control UI

A/V2 : Control DTV Remote control UI

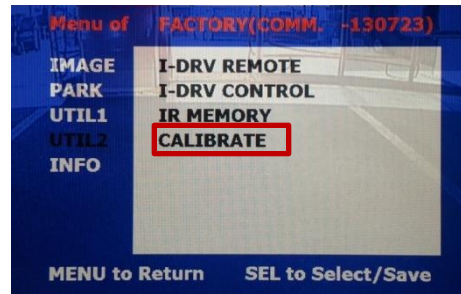
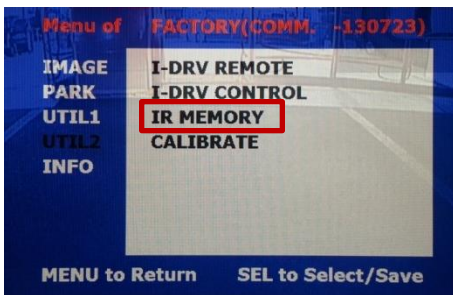

UTIL2 – IR MEMORY

To register DVD, DTV remote control, the remote control value must be registered and can be control with touch DVD(A/V1), DTV(A/V2)

※ To use this function, in UTIL2-I_DRV REMOTE select USER mode

UTIL2 – CALIBRATE

Touch Calibration

YES / NO

3. Settings

3.3.3 FACTORY MODE-UTIL2

FACTORY mode – Press ◀ button 2 seconds long on the remote control.

□ UTIL2 – IR MEMORY

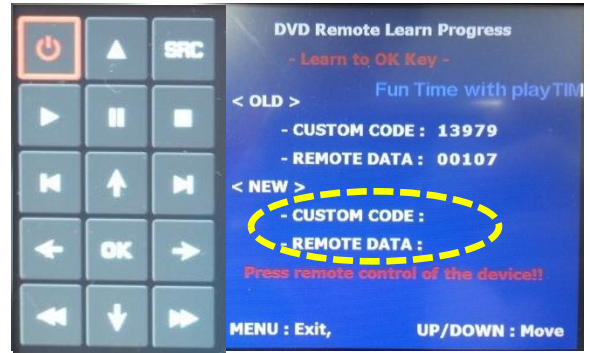

- ① First of all, press ◀ button on remote controller 2 seconds long or press UP→DOWN→UP→MENU button in order to access Factory mode. Choose IR MEMORY on UTIL2.

In IR MEMORY, you can choose AV source of DTV and DVD you want to use.

- ② Picture above shows DVD remote control button value input, select menu you want to save. (To register DVD remote control button value, select IR MEMORY – DTV and follow below instructions.

example)

- a. Move to button where you want to save on the remote control. Use only up and down button.
- b. Press OK button on provided remote control, press the remote control button and the value will be registered.

What is IR-MEMORY Mode?

Is to allow touch screen to control other DVD or DTV (besides the existing,; for example : SANYO, NECVOX) by register remote control value.

3. Settings

3.3.3 FACTORY MODE-UTIL2

FACTORY mode – Press ◀ button 2 seconds long on the remote control.

□ UTIL2 – IR MEMORY



example) continue..

c. When you press device's remote control button, at the same time button value will appear (see picture above), and will turn to green for automatic save.

d. Do these steps to input other button value.

- ③ After register, select "SRC" button in OSD menu. Then you can see confirmation window as shown above. At the moment, (If data is saved, DVD TYPE and DTV TYPE will be changed to "USER" automatically.)

If you see "SUCCESS" on screen, the data is saved clearly and you can control DVD via touch screen. BUT, you MUST change the option in FACTORY-UTIL2-I_DRV REMOTE to "USER".

※ When touch the middle of the screen, you can control DVD, DTV using remote control UI via touch screen

※ If touch the screen in DVD(A/V1), DTV(A/V2) mode, Can see remote control UI
If touch the screen in RGB, A/V3 mode, Can see mode switching UI

- If you want to see mode switching UI in DVD, DTV mode, Select "SRC" button

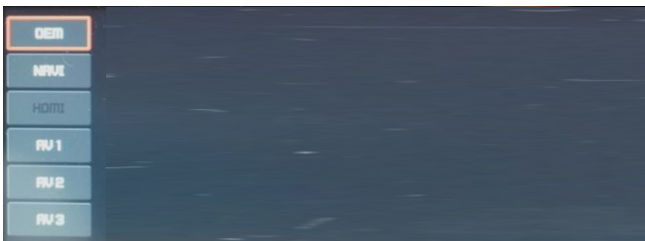

3. Settings

3.3.3 FACTORY MODE-UTIL2

FACTORY mode – Press ◀ button 2 seconds long on the remote control.

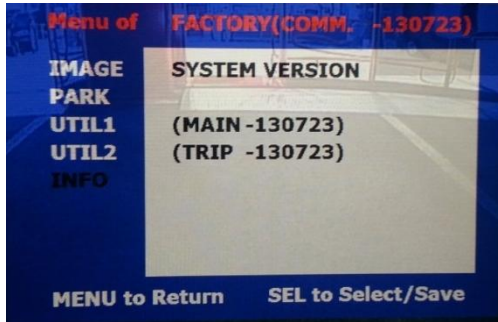

INFO

Check main version and Trip version

3. Settings

3.4 Original Button Usage

※ User can switch mode using original button in steering wheel

* Press longer : Switching mode(RGB→A/V1~3→Original mode)

* Press shorter : Move to Original mode



< Model with "I NAV" Button >



※ FACTORY MODE→UTIL1→
CAR MODEL→A4L-NEW



<Model without "I NAV" Button>



※ FACTORY MODE→UTIL1→
CAR MODEL→A4L-OLD

3. Settings

3.5 OSD (On Screen Display) / Analog RGB Mode



□ IMAGE

- * BRIGHTNESS
- * CONTRAST
- * SHARPNESS

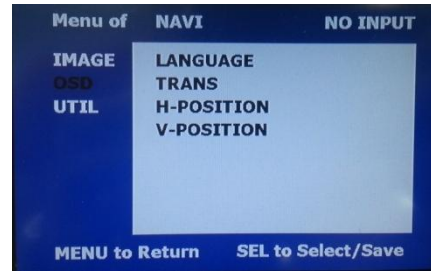

□ OSD

- * LANGUAGE : Set OSD language (only support English and Chinese)
- * TRANS : Adjust OSD transparency
- * H-POSITION : Move OSD horizontally
- * V-POSITION : Move OSD vertically



□ UTIL

- * FACTORY RESET
: Factory reset only for OSD function
(unable reset video position)

3. Settings

3.5 OSD (On Screen Display) / Video Mode



□ IMAGE

- * BRIGHTNESS
- * CONTRAST
- * SATURATION
- * HUE
- * SHARPNESS

□ OSD

- * LANGUAGE : Set OSD language (only support English and Chinese)
- * TRANS : Adjust OSD transparency
- * H_POSITION : Move OSD horizontally
- * V_POSITION : Move OSD vertically

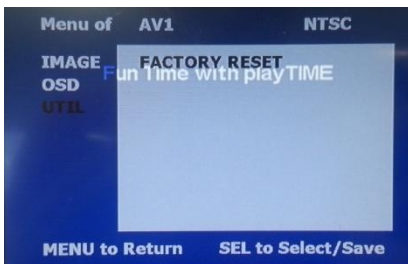

□ UTIL

- * FACTORY RESET
: Factory reset only for OSD function
(unable reset video position)

4. Trouble Shooting

Q. I cannot change mode

- A. Check connection of Ground cable and IR Cable.
Check LED lamp is on, if not check connection of POWER cable.

Q. All I got on the screen is black.

- A. .Check second LED lamp of the interface is on, if not, check A/V sources connected are working well.
(Second lamp indicates AV sources connected works well.) Check interface connection has been done well.

Q. Displayed image color is not proper (too dark or unsuitable color)

- A. Try to select "INITIAL" in OSD menu, if it does not work, inform to manufacturer.

Q. I cannot watch the rear camera on the screen

- A. Set the DIP switch #7 as state "ON".

Q. Set mode not appear

- A. Check DIP Switch.

Q. OEM image is not displayed.

- A. Check interface's LCD In/Out cable connection. If the status keeps on, inform to manufacturer.

Q. Screen only displays white color.

- A. Check LCD out cable is connected well, if this status keeps, inform to manufacturer.

Q. Show PIP function via handle button, and original screen appear half only.

- A. This is not because of faulty interface, please check original monitor split function settings.

Q. After connect CAN cable, set gear "P", video doesn't appear.

- A. Go to "FACTORY MODE" and check "UTIL-Rear Select". Change "LAMP" settings to "CAN" with remote control.

※ LAMP : In case of connecting "Rear-C" wire of Power Cable to Rear Lamp in vehicle.

It may not work on a camera with 12V



RM #404 4TH FLOOR, B-DONG,
WOORIMLIONSVALLY, 371-28, GASAN-DONG,
GEUMCHEON-GU, SEOUL, KOREA.
TEL : 82-2-868-3627~9 | FAX : 82-2-2026-5987